

madita-fun.



Instructions for use.

madita-fun. The modern, integrative therapy chair.

schuchmann®

Our promise.



Dear Customer,

at this point we would like to thank you for placing your trust in our company and for purchasing our product. We ask you to read through the Instructions for use carefully prior to initial commissioning of the product, and to observe them. Please note that guidelines and representations in these Instructions for use may deviate from your product due to differing equipment.

We reserve the right to make technical modifications.

Important information!

Ensure that these Instructions for use remain with the product..

Your **schuchmann**-Team



1. Preparation.	05
1.1 Delivery	05
1.2 Safety measures prior to use	05
1.3 Safe disposal	05
1.3.1 Packaging	05
1.3.2 Produkt	05
1.4 Where to store the Instructions for use	05
2. Product description.	06
2.1 Material information	06
2.2 Handling / transport	06
2.3 Application areas, use according to the intended purpose	06
2.4 Use not in accordance with the intended purpose / warning guidelines	07
2.5 Equipment for basic model	07
2.6 Auflistung Zubehör	08
2.7 Product overview	08
Settings	
3.1 Seat height	09
3.2 Seat angle	10
3.3 Seat depth	10
3.4 Back inclination	10
3.5 Back height	11
3.6 Armrests	11
3.7 Foot support	12
3.8 Footrests	13
3.8.1 Positioning of the footrests	14
3.9 Footrests with foot pans	15
4. Accessories.	16
4.1 Headrest	16
4.2 Conversion kit for combination sub-frame	16
4.3 Removable back	17
4.4 Thorax pelotte pads	17
4.5 Foldable thorax pelotte pads	17
4.6 Thigh guide	18
4.7 Abducting leg guides	18
4.8 Adjustable pelvic guide	19
4.9 Parking brake	19
4.10 Anti-tip mechanism	19
4.11 Therapy table	19
4.12 Knee abduction wedge	20
4.13 Wheel base extension	20

5. Repairs and cleaning.	20
5.1 Cleaning.....	20
5.2 Repairs	20
5.3 Spare parts.....	20
5.4 Duration of use and re-use.....	21
6. Technical data.	21
7. Guarantee.	22
8. Identification.	23
8.1 EC declaration of conformity.....	23
8.2 Serial number / date of manufacture	24
8.3 Product version.....	24
8.4 Ausgabe des Dokuments.....	24
8.5 Name and address of the manufacturer, specialist dealer supplying the product.....	24



1. Preparation.

1.1 Delivery

On receiving the product, please check it for completeness, lack of faults and any transport damage. Inspect the goods in the presence of your forwarder. Should transport damage have occurred, please arrange for an inventory (determination of the faults) to be made in the presence of the forwarder. Please send a complaint in writing to the specialist dealer responsible.

1.2 Safety measures prior to use

Correct usage of the therapy chair requires precise and careful training of the accompanying person. We ask you to read through the Instructions for use carefully prior to initial commissioning of the therapy chair, and to observe them. Cushioned parts, in particular armrests, may become hot when exposed to direct sunlight. Cover these parts or protect the equipment from direct sunlight.

1.3 Safe disposal

In order to preserve and protect the environment, to prevent environmental pollution and to improve the recycling of raw materials, please note the disposal instructions in **points 1.3.1** and **1.3.2**.

1.3.1 Packaging

The product packaging should be stored in case the product needs to be transported again. Should you have to return the product for repairs or in case of a guarantee claim, please if possible use the original box so that the product is optimally packaged. Separate the packaging materials for recycling according to their classification. Do not leave packaging materials unattended, as they are a possible source of danger.

1.3.2 Produkt

Separate the raw materials used in the product for recycling according to their classification (see material information under **2.1**)

1.4 Where to store the Instructions for use

Please store these Instructions for use carefully and ensure that these Instructions for use remain with the product in case of re-use.



2. Product description.

2.1 Material information

The base frame and the individual elements are made of steel and aluminium which are non-corroding and powder-coated. The covers are made of 100% polyester and are flame resistant (according to DIN EN 1021-1+2).

2.2 Handling / transport

The therapy chair is not designed to be carried, as it is fitted with castors. Should you have to carry the equipment due to obstacles, ensure that all moving parts are tightened. Then position yourself next to the therapy chair, grip it at the front and rear under the seat unit and carry it to the required location. To transport the therapy chair, reduce all adjustments to their most compact size (fold up foot support, set lowest seat height etc.)



Tighten all moving parts prior to carrying!



The child may not be located in the therapy chair whilst it is being transported!

2.3 Application areas, use according to the intended purpose

The **madita-fun.** therapy chair has been designed for children and teenagers who are unable to sit or stand independently, but whose limited torso posture does not continuously require sitting in a seat pan. The **madita-fun.** is a flexible-use therapy chair which grows with the child for use at home, in nursery school and at school, and can be used for all age classes from toddler to teenager. Individually adjustable seat dimensions and supporting pelotte pads allow a stable and upright sitting position.

2. Product description.



2.4 Use not in accordance with the intended purpose / warning guidelines

- Ensure that the therapy chair is only used by one child/teenager.
- Only use the therapy chair on an even and solid surface.
- Do not use the therapy chair to transport people.
- In order to guarantee safe lifting when transporting the therapy chair, stand at the side of the therapy chair and grasp the front and back of the seat surface. Here all movable parts should be tightened.
- Never leave the child unattended in the therapy chair.
- Correct usage of the therapy chair requires precise and careful training of the accompanying person.
- The max. load (see **point 6**) may not be exceeded.
- Do not use the therapy chair if it has defective, worn or missing parts.
- For reasons of fire safety, the therapy chair may not be placed close to an open fire or any other strong source of heat such as electric or gas heaters.
- Only use accessories and spare parts made by Schuchmann, otherwise you will endanger the child.
- Only use the therapy chair if all components have been correctly mounted and adjusted.
- Please ensure that none of the user's extremities are in the respective area when making adjustments of any kind to minimise the risk of injury.
- Please read out the Instructions for use for users suffering from a visual or reading impairment, so that they can use the therapy chair safely.

2.5 Equipment for basic model

- Incl. armrests, foot support, push handle, standard seat pad with cover
- Seat height can be adjusted with gas pressure spring assistance (1200N, 800N for Size 0)
- 4 castors (75 mm), of these 2 with locking devices
- Adjustment possibilities: Seat angle (via gas pressure spring 500N), back angle, seat depth and seat width, angle, height and width-adjustable armrests, height-adjustable backrest, foldable foot support, adjustable knee angle, foot angle and height



2. Product description.

2.6 List Accessories

- Headrest
- Removable back
- Thorax pelotte pads (also foldable)
- Thigh guide
- Adjustable pelvic guide
- Therapy table
- Knee abduction wedge
- Conversion kit for combination subframe
- Central parking brake
- Hydraulic height adjustment
- Electrical height adjustment
- Anti-tip mechanism
- Incontinence coating
- Wheel base extension
- Strap assembly kit for the seat area
- Strap assembly kit for the back area
- Incontinence coating
- Fixing aids

2.7 Product overview

The Fig. below is intended to show you the designation of the most important components as well as the terms which you will find in these Instructions for use.



3. Settings.

Settings and adjustments to the product or accessories may only be made by people who have been given the necessary instructions by a medical product advisor. Please ensure that none of the user's extremities are in the respective area when making adjustments of any kind to minimise the risk of injury.

3.1 Seat height

The seat height is adjusted using a gas pressure spring. In order to adjust the seat height upwards, the foot pedal (A) on the base frame is actuated. By pressing it lightly, the seat unit slides upwards. Lowering is achieved through pressure from above onto the seat whilst at the same time operating the foot pedal. The gas pressure spring serves merely to assist with adjustment of the height. The foot pedal can be secured against inadvertent operation with the spring pin (B) (located on the inside of the foot pedal). To do this, turn the spring pin until it engages. If necessary, assist engagement by moving the foot pedal gently. The locking effect is cancelled by pulling out the spring pin and turning it a quarter turn.

Alternatively, the seat height can be adjusted using the hydraulic height adjustment. In order to bring the therapy chair up, pump the pedal (C) until the chair reaches the required height. In order to lower the therapy chair, place a foot under the pedal (C) and press it upwards.

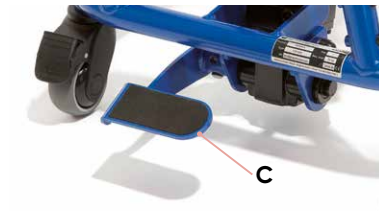
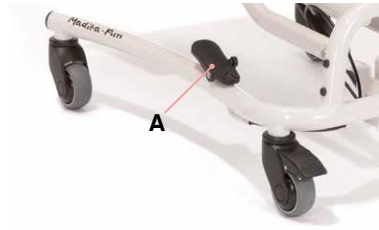

Ensure that, during setting / adjustment of the seat height, no body parts (feet) are trapped in the area of the setting / adjustment mechanism (between the floor and the footrest of the therapy chair) in order to avoid injuries



3. Settings.

Electrical height adjustment is also possible. This is operated with the existing remote operation (A). Press the arrow key downwards in order to adjust the seat height downwards and upwards in order to adjust the seat height upwards.



In case of problems with the control unit, please contact a specialist dealer so that the product can be returned to the factory if required. As soon as the housing is opened, the Linak sticker (B) is damaged, whereupon the 2-year guarantee automatically expires.

3.2 Seat angle

The lever for the seat angle adjustment is equipped with a child lock. In order to adjust the angle of the seat unit, the hand trigger (C) at the rear below the seat pan holder must be actuated by pushing it together horizontally until it engages. The seat unit can now be adjusted in an active or passive position. It is optionally possible to mount the release handle (D) for the seat angle adjustment on the push bar / handle. To adjust the seat angle (D), simply activate the release handle (D).

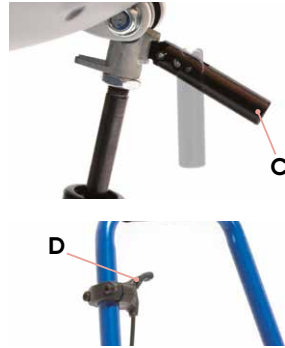

3.3 Seat depth

To adjust the seat depth, loosen the two wing screws (E) under the seat unit. Then the seat surface can be moved continuously forwards or backwards.



After each adjustment, please retighten all screw connections!

3.4 Back inclination

Der Rücken lässt sich nach Lösen des Klemmhebels (F) auf der rechten Seite der Sitzeinheit im Winkel verstellen.



Ensure that, during setting / adjustment of the back inclination, no body parts are trapped in the area of the setting / adjustment mechanism in order to avoid injuries.



3. Settings.

3.5 Back height

Loosen the cylinder head screw (A) with the hexagonal wrench (M8) at the rear and bring the back into the required height.



3.6 Armrests

The armrests can be adjusted in angle, height and width. The angular adjustment takes place after loosening the star knob (B). The height can be adjusted through loosening the star knob (C).



The width adjustment takes place after loosening the two grub screws (D), which are located on the underside of the seat unit.

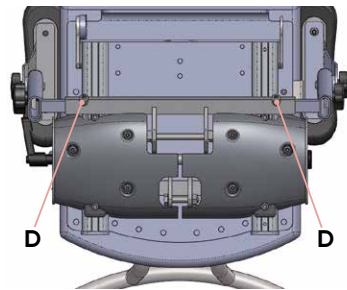

After each adjustment, please retighten all screw connections!

3. Settings.

3.7 Foot support

A foot support (A) is already included in the basic model of the MADITA-Fun therapy chair. This has a non-slip surface (B) and has 8 slots (C) for fixing straps such as foot cuffs or foot fixing straps. In order to adjust the knee angle, please loosen the clamping lever (D) under the seat surface, bring the foot support into the required position and retighten the clamping lever (D). The foot support can be folded up in order, for example, to facilitate climbing in (E).

In order to continuously adjust the height, please loosen the four grub screws (F), bring the foot support into the required position and retighten the grub screws (F). When adjusting the height, please ensure that the markings (G) on the adapter tubes of the foot support are not exceeded in order to guarantee secure clamping through the grub screws (F). The foot angle can also be adjusted for optimum positioning of the feet. To do this, first fold the foot support upwards and then screw the hexagon socket screws (H) in or out. Counter the nuts (I) after each foot angle adjustment.

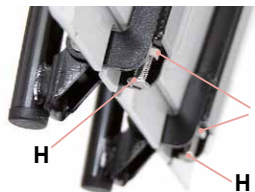
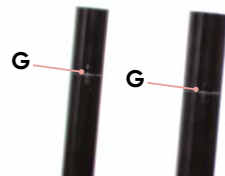
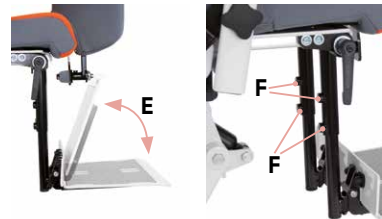
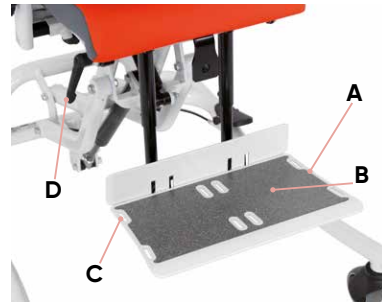

Counter the nuts (I) after each foot angle adjustment!



After each adjustment, please retighten the clamping lever and the grub screws!

3. Settings.

3.8 Footrests

Optionally, **madita-fun.** can also be equipped with footrests (A). These have a non-slip surface (B) and have 4 slots each (C) for fixing straps such as foot cuffs or foot fixing straps. For adjustment of the knee angle, please loosen the clamping lever (D) under the seat surface on both sides, bring the footrests into the required position and retighten the clamping lever (D). The footrests can be folded up, for example in order to facilitate climbing in (E). For continuous height adjustment, please loosen the two grub screws (F) on each footrest, bring the footrests into the required position and retighten the grub screws (F). During height adjustment, please ensure that the markings (G) on the adapter tubes of the footrests are not exceeded in order to guarantee secure clamping through the grub screws (F).

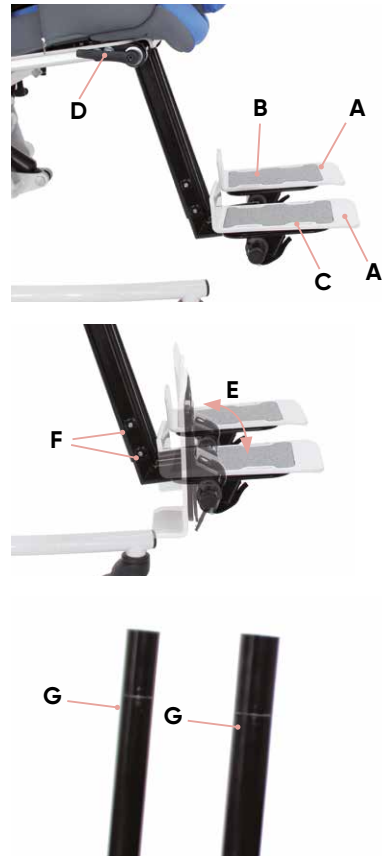

After each adjustment, please retighten the clamping lever and the grub screws!



3. Settings.

3.8.1 Positioning of the footrests

For optimum positioning of the feet, the footrests can be adjusted independently of each other in width, angle and depth.

Width

In order to adjust the width (C), please loosen the pan head screws (D) under the footrests, bring the footrest into the required position and retighten the pan head screws (D).

Angle / depth

In order to adjust the angle and the depth (E), please loosen the pan head screws (F) under the footrests, bring the footrest into the required position and retighten the pan head screws (F). In addition, additional width adjustments can also be made in this way.

Securing against folding up

The footrests can be secured against unwanted folding up. To do this, simply loosen the hook and eye fastener (G) under the footrest, bring the footrest into the required position and close the hook and eye fastener (G) again.



After each adjustment, please retighten all screw connections!

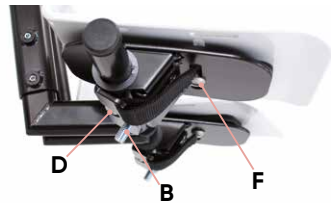
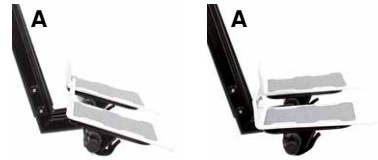

3. Settings.

3.9 Footrests with foot pans

Optionally, the footrests can also be equipped with foot pans (A). Here, as on the standard design, the knee angle can be adjusted, the foot pans folded up and the height adjusted (see **point 3.8**). For optimum positioning of the feet, the footrests with foot pans can be adjusted independently of each other in width, angle and depth (see **point 3.8.1**).

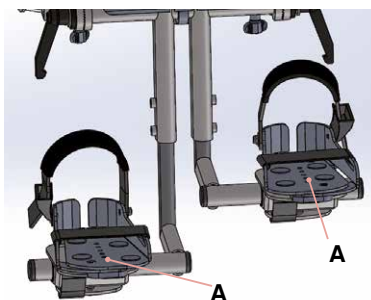

After each adjustment, please retighten all screw connections!

3.10 Castors

The therapy chair should always be prevented from rolling away inadvertently through braking of the 2 rear castors. To do this, press the brakes (B) down with the tip of your foot.



The brake serves merely to prevent inadvertent rolling away on level surfaces!

4. Accessories.

4.1 Headrest

The headrest can be adjusted in height, depth and angle. In order to do this, please loosen the 2 cylinder head screws (A) with a hexagonal wrench and bring the headrest into the required position.



4.2 Conversion kit for combination sub-frame

When retrofitting the **maditā-fun.** to the combination sub-frame, the plastic castors are replaced through 6" pneumatic tyres with castor forks and 12 1/2" drum brake wheels. The drum brakes work independent of air pressure. They are integrated into the wheel hubs and cannot be accessed. They provide the companion to the user the possibility of assisting with the braking action (in particular when driving down hills) and of locking the sub-frame. This is conducted through the two brake levers (B) which are mounted onto the push handle. The drum brakes are set by turning the setting screws in or out. They are located at the lower end of the brake cables in the brake saddle. Leave this work to your specialist dealer in case of any uncertainty.



Handling the wheels on the combination sub-frame

The following general rules apply:

High air pressure: Low rolling resistance / less suspension comfort

Low air pressure: Higher rolling resistance / more suspension comfort

4. Accessories.

4.3 Removable back

The removable back can be operated on the back of the therapy chair. Loosen the turning handle (A), press the locking lever (B) together and then remove the back.

The function of the removable back can be integrated into the therapy plan and also used for short periods of time, as the back, including the headrest, is quickly plugged in again, and provides the child with a positioner and support when they are tired.

After each adjustment, please retighten all screw connections!



4.4 Thorax pelotte pads

The thorax pelotte pads are individually adjustable in height and width. In order to do this, please loosen the 2 pan head screws with a hexagonal wrench (A) and bring the thorax pelotte pads into the required position.

4.5 Foldable thorax pelotte pads

The foldable thorax pelotte pads can be folded to the sides to ease placement of the child. To do this, please press the red pushbutton (B) on the side of the thorax pelotte pad over the joint, and swivel the pelotte pad away to the side.



When folding back, ensure that the thorax pelotte pad engages!



4. Accessories.

4.6 Thigh guide

The thigh guide pads are individually adjustable in height and depth. In order to adjust the depth, loosen the nuts **(A)** under the seat area and bring the thigh guide pad into the required position. The depth adjustment is possible on any thigh guide except on the standard version for Size 0 with adjustable pelvic guide. In order to adjust the height, please open the zips **(B)**, loosen the 3 pan head screws **(E)** with a hexagonal wrench and bring the pad into the required position.

After each adjustment, please retighten all screw connections!



4.7 Abducting leg guides

The abducting leg guides permit the medically necessary abduction of the thighs and the compensation of a seat depth difference. In order to adjust the leg guides, please loosen the nuts **(A)** below the seat surface, and bring the leg guides into the required position. You can easily adjust the abduction angle **(1)**, the thigh width **(2)** and also the leg length compensation or seat depth difference **(3)** via the slotted holes whilst the child is sitting in the therapy chair.

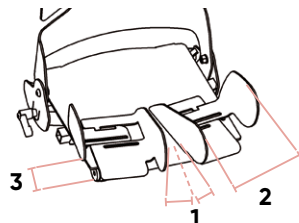
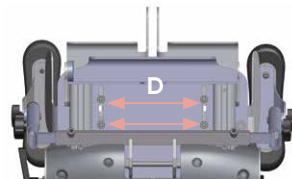
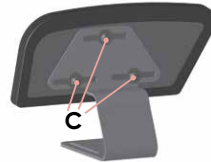
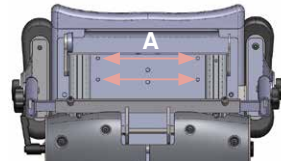

4. Accessories.

4.8 Adjustable pelvic guide

The adjustable pelvic guide can be adjusted in width, provides the child with a high level of security and positions the pelvis. First loosen the cylinder head screw on the rear of the therapy chair at the lower edge of the cover (A). Then push the front of the pad down slightly and loosen the hexagon socket screw (B). Now please place the child into the chair and bring the adjustable pelvic guide into the required position. First retighten the cylinder head screw (A) and then remove the child again. Now you only need to tighten the hexagon socket screw (B) and then you can place the child back in the chair.

Ziehen Sie nach jeder Einstellung die Schraubverbindungen wieder fest!

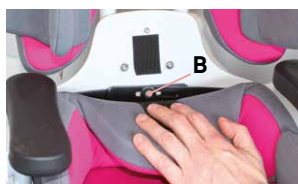
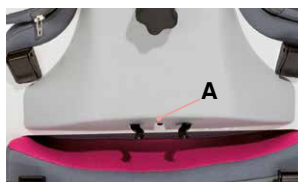
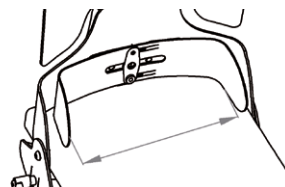

4.9 Parking brake

The parking brake can be used by the user themselves. If the lever (C) is pressed down, the brake is released. If the lever is pointing upwards, the brake is applied.



4.10 Anti-tip mechanism

The anti-tip mechanism is adjustable in height. To adjust the height, open the lever (D), position the anti-tip mechanism to the required height and close the lever once more.



4.11 Therapy table

The therapy table can be adjusted in height and depth. Height adjustment takes place via adjustment of the armrests (see **point 3.6**). For adjustment of the depth, loosen the wing screw (E) and bring the therapy table into the required position. In order to fold the therapy table to the side, for example when the child gets in or out, loosen the wing screws (E+F), swivel the table upwards and guide it to the side of the therapy chair (G).

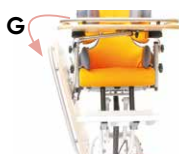

4. Accessories.

4.12 Knee abduction wedge

The knee abduction wedge must be mounted onto the front of the seat plate using a quickrelease axle. To do this, please press the knob (A) on the quick-release axle, and the abduction wedge can easily be removed or inserted. When inserting the abduction wedge, you should be able to hear it engage with an audible „click“.



4.13 Wheel base extension

The wheel base extension (B) cannot be adjusted! It is inserted at the front of the frame and serves only for stability.

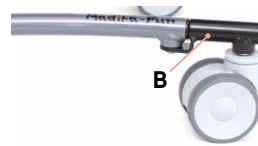

After each adjustment, please retighten all screw connections!

5. Repairs and cleaning.

5.1 Cleaning

Please clean all frame elements with a sponge or damp cloth. The covers can be removed and washed at 30° in the washing machine. Please do not dry the covers in a dryer and do not use aggressive cleaning agents or similar products. Please also pay attention to our general cleaning and hygiene advice. You can find this on www.schuchmann.de/madita-fun.

5.2 Repairs

Please carry out a daily visual inspection and check the therapy chair regularly for cracks, breaks, missing parts and malfunctions. In case of a defect or malfunction, please contact the specialist dealer who supplied you with the product (see 8.5).

5.3 Spare parts

Should you wish to order spare parts, please contact the specialist dealer who supplied you with the product, stating the serial number of the therapy chair (see 8.5). Necessary spare parts and accessories must only be installed by trained personnel.

5. Instandhalten und Reinigen.

5.4 Duration of use and re-use

The expected duration of use of our product, dependent on the usage intensity and amount of re-use, totals up to „8“ years if the usage takes place in accordance with the information in these Instructions for use. It may be possible to use the product over and above this time period if it is in a safe condition. The expected duration of use does not refer to wear parts, such as for example covers, wheels, batteries..... The maintenance and evaluation of the condition, and if applicable the potential for re-use, must be decided by the specialist dealer. The therapy chair is suitable for re-use. Prior to forwarding on, please follow the cleaning and disinfection instructions in **Chapter 5**. Accompanying documents such as these Instructions for use are part of the product and must be passed on to the new user. No disassembly is required prior to re-use. In the case of storage, it is recommended to fold the product to the smallest dimension to save space.

6. Technical data.

Dimensions - basic model

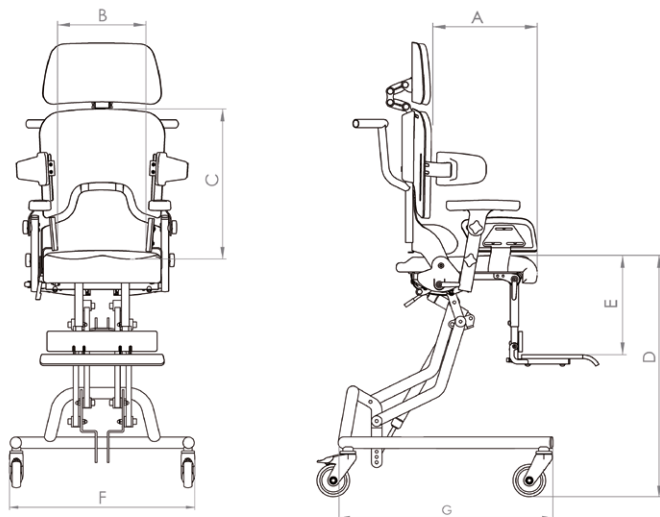

6. Technical data.

		Size 0	Size 1	Size 1 b	Size 2
A	Seat depth	15 - 25 cm	21 - 30 cm	26 - 36 cm	30 - 42 cm
B	Seat width	16 - 26 cm	20 - 30 cm	20 - 30 cm	28 - 38 cm
C	Back height with short back	35 - 43 cm	35 - 43 cm	42 - 52 cm	42 - 52 cm
C	Back height with long back	42 - 52 cm	42 - 52 cm	53 - 63 cm	53 - 63 cm
D	Seat height	25 - 62 cm	25 - 62 cm	25 - 62 cm	25 - 62 cm
	Seat height with electric height adjustment	32 - 62 cm	32 - 62 cm	32 - 62 cm	32 - 62 cm
	Seat height with hydraulic height adjustment	27 - 63 cm	27 - 63 cm	27 - 63 cm	27 - 63 cm
E	Lower leg length	17 - 24 cm	22 - 32 cm	27 - 38 cm	30 - 48 cm
F	Total width	52 cm	54 cm	64 cm	64 cm
G	Length of base frame	58 cm	61 cm	75 cm	75 cm
	Total length with combination subframe	71 cm	76 cm	86 cm	86 cm
	Seat angle	(-)8° - 37°	(-)8° - 37°	(-)8° - 37°	(-)8° - 37°
	Back angle	(-)5° - 25°	(-)5° - 25°	(-)5° - 25°	(-)5° - 25°
	Max. load	30 kg	30 kg	45 kg	50 kg
	Weight	19 kg	20 kg	22 kg	24 kg

7. Guarantee.

The two-year statutory guarantee period shall apply for all products. This begins with the delivery or handover of the goods.. Should a verifiable material or manufacturing fault occur within this time period, we shall, after carriage paid return to us, view the indicated damage and, if applicable, either repair or deliver a new product at our discretion.

8. Identification.

8.1 EC declaration of conformity

Company Schuchmann GmbH & Co.KG
 Dütestr. 3
 D-49205 Hasbergen
 Tel.: +49 (0) 54 05 / 909 - 0
 Fax: +49 (0) 54 05 / 909 - 109



declares on their sole responsibility that the product named below, classified in product class 1,

madita-fun. The modern, integrative therapy chair.

Art. No.: 74 00 000 (Size 0) 74 01 100 (Size 1b)
 74 01 000 (Size 1) 74 02 000 (Size 2)

accords with the relevant provisions in the regulations and guidelines listed below:

- EC Directive 93/42/EEC on medical products from 14th June 1993
- DIN EN 12182 Technical aids for the disabled
- EN ISO 14971 Medical products - Application of risk management on medical products

This declaration of conformity applies only for products with the article numbers stated above and is valid until 31.12.2019.

Date 06.07.2017

Signature 

Name Torsten Schuchmann

Function Safety Representative for Medical Products



8. Identification.

8.2 Serial number / date of manufacture

The serial number, the date of manufacture and other information can be found on the type plate, which is located on all of our products (**A**).

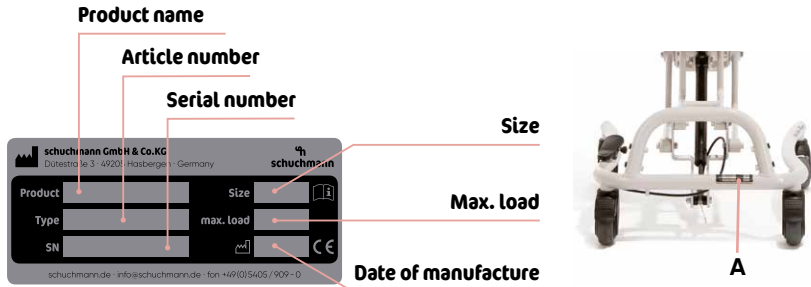

8.3 Product version

The **madita-fun.** therapy chair is available in three sizes and can be supplemented through a wide range of accessories (see **point 3**).

8.4 Ausgabe des Dokuments

Instructions for use **madita-fun.** – Change status J; Issue 09.2018

8.5 Name and address of the manufacturer, specialist dealer supplying the product

This product was manufactured by:



Schuchmann GmbH & Co. KG

Dütestraße 3 · 49205 Hasbergen

Tel. +49 (0)5405/909-0 · Fax +49 (0)5405/909-109

info@schuchmann.de · www.schuchmann.de

This product has been delivered by the following specialist dealer: